



Product Data Sheet

Product Model: ASP-LAM-179W

Nominal Power: 179 ± 9 W

performance at STC: $1000\text{W}/\text{m}^2$, 25°C , AM1.5

Nominal Power (P_m)	179	W
Open Circuit Voltage (V_{oc})	89.9	V
Short Circuit Current (I_{sc})	2.91	A
Voltage at max. Power (V_m)	70.6	V
Current at max. Power (I_m)	2.54	A
Power Output	25 years power output guarantee, for 90% of nominal output during first 10 years and 80% over 25 years.	
materials and workmanship	10 years	

System Properties (at STC)

Maximum System Voltage	V_{sys} (V)	1000 (600UL)
Maximum Series Fuse	I_{CF} (A)	4.6

Temperature Coefficients (at STC)

Temperature Coefficients of I_{sc}	$\alpha = 0.060\%/^\circ\text{C}$
Temperature Coefficients of V_{oc}	$\beta = -0.321\%/^\circ\text{C}$
Temperature Coefficients of P_m	$\gamma = -0.214\%/^\circ\text{C}$

Mechanical Specifications

Length	3000 ($0 \sim +3$) mm
Width	900 ($0 \sim +3$) mm
Thickness	18.0 (± 1) mm
Area	2.7m ²
Weight	107.6kg



龙焱能源科技（杭州）有限公司
ADVANCED SOLAR POWER (HANGZHOU) INC

Frame	N/A
Junction Box※	900mm edge center, paralleled to transparent line
Lead Cable	2.5mm ² , 650mm
Connectors	MC4
Bypass Diode	6A
Cell Type	CdTe
Structure	6.0mm+3.2mm+6.0mm Heat-strengthened/Cell/Heat-strengthened
Encapsulation	PVB
Transparency※	40%

※The place of Junction box can be customized.

※Transparency can be customized.

Product schematic drawings:

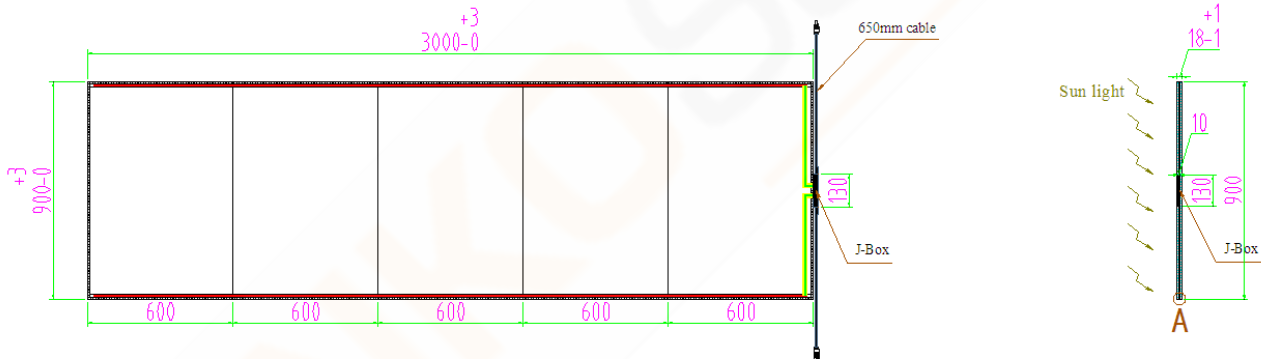

浙江省杭州市下沙经济技术开发区凌云街 801 号
#801 Lingyun Street, Hangzhou Economic & Technological Development Area,
Hangzhou, Zhejiang Province, China
Tel: +86-571-86875500 Fax: +86-571-86908092

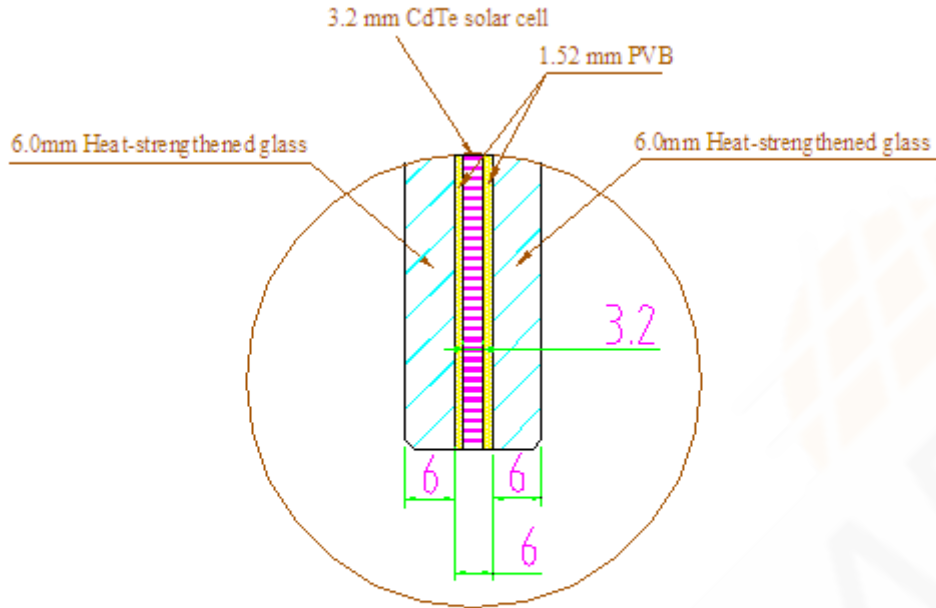

A
1:10